

Installation Instruction User Guides



F-PE

Wireless TX and RX Infrared Beam

Version 1.0

I. Description

1.1 Scenarios of Use

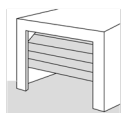

Sectional doors

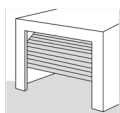

Roller doors

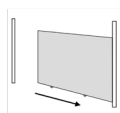

Sliding gates

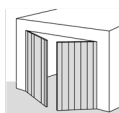

Swing gates

II. Features and Technical Data

2.1 Features

- Complete wireless TX and RX infrared beam with built in lithium battery
- Trio-Frequency technology for anti-interference
- The range of the radio signal of the photocell is above 20 m
- Adjustable switch to adjust the infrared beam transmitting power for various environment
- Low standby and low operating consumption
- Approximate battery life of 2 years under a normal home garage door

2.2 Technical Data

Model	F-PE
Radio technology	Trio-Frequency technology
Frequency	Multi from 409.025 MHz – 458.4 MHz
Signal modulation	FSK
Signal range	20 meters (Indoor or Outdoor)
Power supply	3.6V DC (2 x 3.6V lithium battery for both TX beam and RX beam)
Battery capacity	2600mAh
Adjustable Angle for Tx and Rx	Horizontally (-90° ~ +90°)
TX Operating consumption	7 meters 60ua 13 meters 100ua
RX consumption	Operation 5.3mA Standby 60ua
IP grade	IP 54
Operating temperature	-20°C — + 70°C

III. Product Composition Display

Photo Beam TX



Photo Beam RX

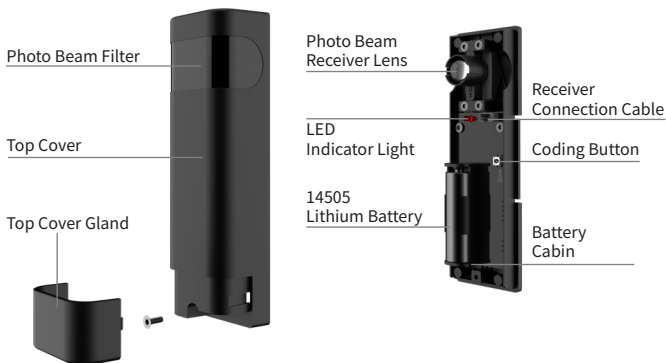

IV. Installation and Configuration

4.1 Tools

For fast and safe installation of photo beam sensors, the following tools are recommended:



Pistol drill



Tape measure



Screwdriver



Pencil

4.2 Installation Steps and Operating Instructions

4.2.1 Prior to installation, first perform a coding test to ensure that the product functions properly and to avoid the inconvenience of coding after installation.

-- Step Instructions:

A. Use a screwdriver to open the wireless photo beam cover and install the appropriate battery.

Note: Only support the 14505 Lithium Battery.

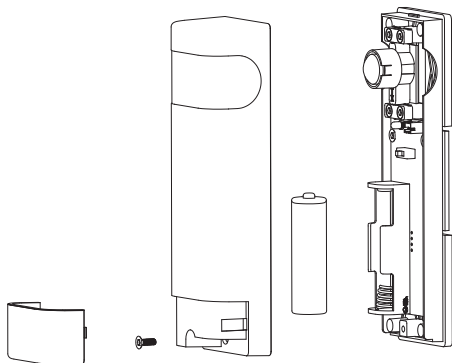

B. Wireless photo beam pairing steps.

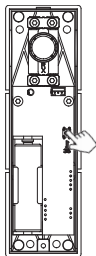

3S



1. Press and hold the wireless accessories coding button ON MOTOR for 3 seconds.

2. Check if the LED light is on and the panel display , it means now the motor now is in pairing mode.

3S



3. Press and hold the Wireless photo beam coding button for 3 seconds.

4. After the LED light ON THE MOTOR flashes, check if the corresponding indicator light is on. (the indicator light color changes according to the device status).

C. Test before installation. Keep the photo beam transmitter and receiver in a straight line. Block the infrared signal when the door is closing. The test is passed if the door bounces.

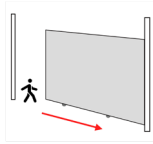
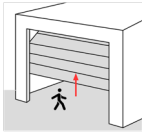

4.2.2 Wireless Photo Beam Installation

-- Step Instructions:

A. Install the mounting bracket according to the position of the door, it is recommended that the bracket is 15-25cm from the ground and 10-15cm from the track.

Photo beam installation drawing for garage door opener

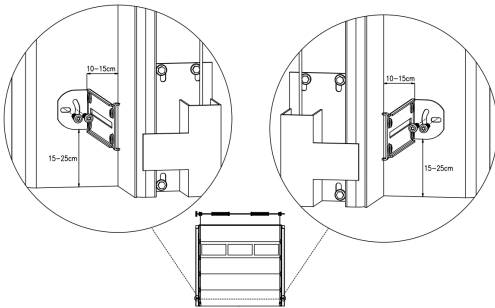
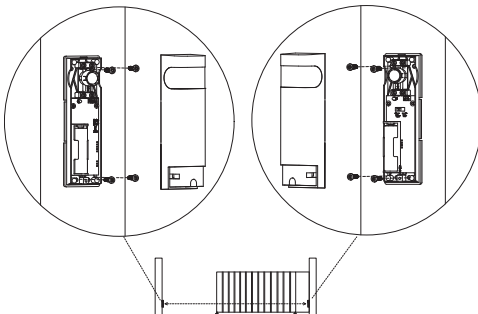

Photo beam installation drawing for sliding gate opener



B. Install the adjustment bracket

Step 1: Place two carriage screws into the adjustment bracket.(Fig.A)

Step 2: Secure the wireless photo beam to the adjustment mounting bracket. (Fig.B)

Step 3: Combine the two brackets to be mounted and secured with nuts.(Fig.C)

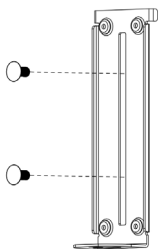

Fig. A

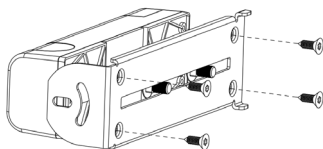

Fig. B

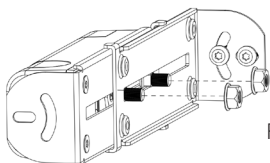

Fig. C

Available for single bracket mounting, or non bracket mounting!

4.3 Parameter Selection and Commissioning

4.3.1 Transmitting Rang Selection:

The transmitting rang can be adjusted by the dip switch, the specific distance correspond as follows:

For doors less than or equal to 7m, adjust the dip switch to the 7m position to save the consumption.

For doors smaller than or equal to 13m, adjust the dip switch to the 13m position to increase the emission strength.

For doors larger than or equal to 13 m, it is not recommended to install this wireless photo beam.

Remark: For outdoor insrallation, recommend the 13m rang to be astronger emission.

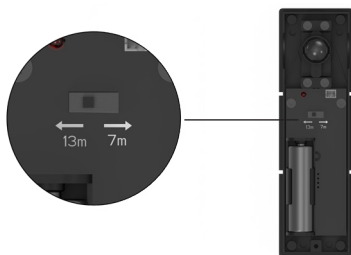

4.3.2 Installation and Commissioning Tests:



Note: The height of the wireless photo beam bracket from the ground and the extension length of the bracket should be the same!

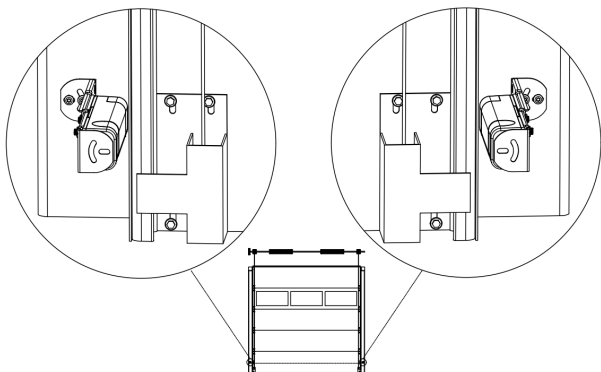

In order to check whether the wireless photo beam RX and TX are aligned when installing, tap the alignment button of the wireless photo beam receiver to enter the installation and commissioning mode.

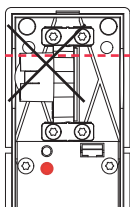
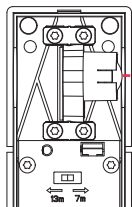
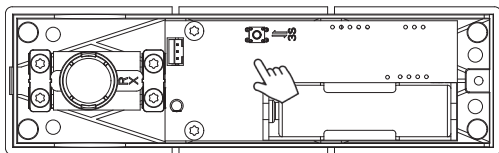

Wireless photo beam transmitter and receiver are not working properly, wireless photo beam receiver LED red light is on. (Need to adjust the receiver/transmitter until the butt light is off)

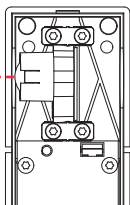
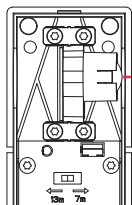

Wireless photo beam transmitter and receiver are working properly, wireless photo beam receiver LED red light on and off. (Test ok)

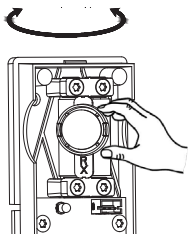

Wireless photo beam transmitter and receiver, can do $-90^{\circ} \sim +90^{\circ}$ adjustment.

4.3.3 Actual test on the doors / gates

- Block the infrared signal when the door is closing. The test is passed if the door bounces.
- Please check the installation and coding if the door doesn't bounce.(refer to 4.2.1B & 4.3.2)

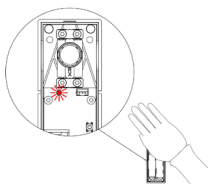

LED lights on

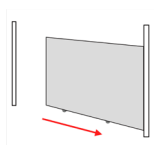
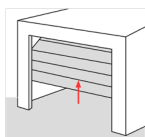

Door /Gate reversed

4.3.4 Installation and testing has been completed, install the top cover according to step 4.2.1A

Install test mode:

State 1: Normal infrared radiation, the installation test mode is to "sleep" state after three minutes;

State 2: In the case of no infrared radiation, the installation test mode is to "sleep" state after ten minutes;



Note: After entering "sleep" state, you can press the infrared beam code button to wake up the device to continue coding.

V. Service Devices

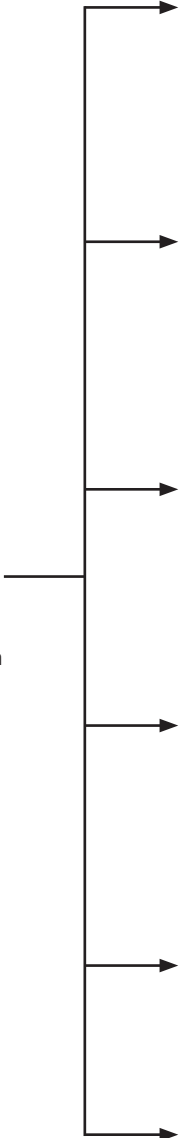

F-box



Receiver For Safety System



Multi-Drive Pro version



Control Box Pro version



Garage Door Opener Pro version

New Coming Products

VI. Appendix

6.1 Packing List

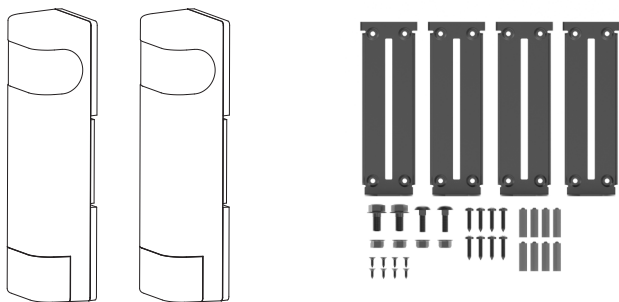

Description	Qty
Wireless photo beam(TX & RX)	1
Mounting brackets	4
Lithium battery	2
Screw pack	1
Manual	1

6.2 Actual Product Dimensions

Unit of Length: mm

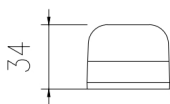
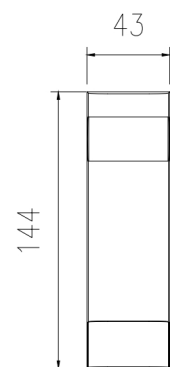

Wireless Photo Beam

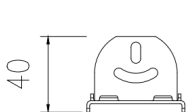
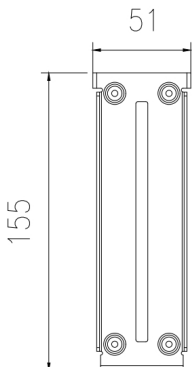

Mounting Bracket

Notes:

1. Low battery warning

- The corresponding indicator light of the product it paired with will be changed. (refer to the corresponding manual for details)
- Push message from the F-linX APP.

2. No power in battery

The door can be opened but can't be closed when the battery is flat or its remaining power doesn't support the wireless photo beam works.

3. Pairing delete

To Cancel the pairing for wireless photo beam, press and hold the  button more than 8 seconds ON THE MOTOR, all the indication lights are shown in red. Then the wireless indication lights will go off. It indicates that all the paired wireless device have been cleared.



 8S



WARNING:

All wireless security devices paired with this motor will be deleted and will need to be paired again. (for details, please refer to the corresponding manual).

4. Replace the batteries

Please use the corresponding tools, open the top cover of the device to replace the 14505 lithium-ion battery.



WARNING:

ONLY support 3.6V, 2600mm 14505 lithium-ion battery.

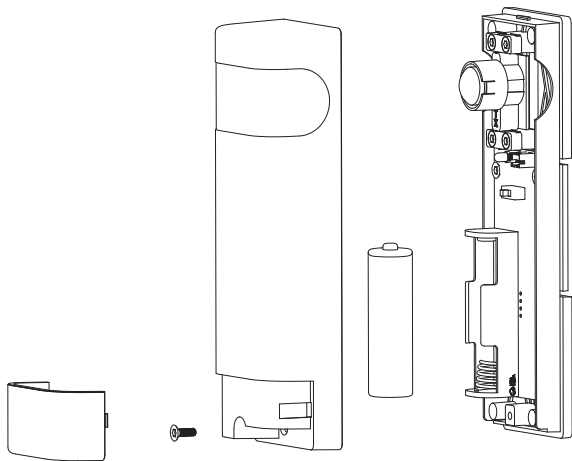

Detailed Instructions for Coding with Related Devices

